

CH 2252 Instrumental Methods of Analysis

Unit –IV

www.msubbu.in

Atomic Absorption Spectroscopy

Dr. M. Subramanian

Associate Professor
Department of Chemical Engineering
Sri Sivasubramaniya Nadar College of Engineering
Kalavakkam – 603 110, Kanchipuram (Dist)
Tamil Nadu, India
msubbu.in@gmail.com



Contents

- Atomic Absorption Spectroscopy (AAS):
Principle, Instrumentation, Interference and Applications.

www.msubbu.in

Introduction

- AAS was developed in the 1950s. AAS is an elemental analysis technique capable of providing quantitative information on 70 elements in almost any type of sample.
- As an elemental analysis technique, it has the significant advantage in many cases (but not all) of being practically independent of the chemical form of the element in the sample.
- Concentrations as low as ppt levels of some elements in solution can be determined, and AAS is used routinely to determine ppb and ppm concentrations of most metal elements.
- The major disadvantages of AAS are that no information is obtained on the chemical form of the analyte (no "speciation") and that often only one element can be determined at a time. This last disadvantage makes AAS of very limited use for qualitative analysis.

Principle of AAS

- AAS is based on the absorption of radiant energy by free gas phase atoms. In the process of absorption, an atom changes from a low-energy state to a higher energy state
- The electrons of the atoms in the atomizer can be promoted to higher orbitals for a short amount of time by absorbing a set quantity of energy (i.e. light of a given wavelength). This amount of energy (or wavelength) is specific to a particular electron transition in a particular element, and in general, each wavelength corresponds to only one element. This gives the technique its elemental selectivity.

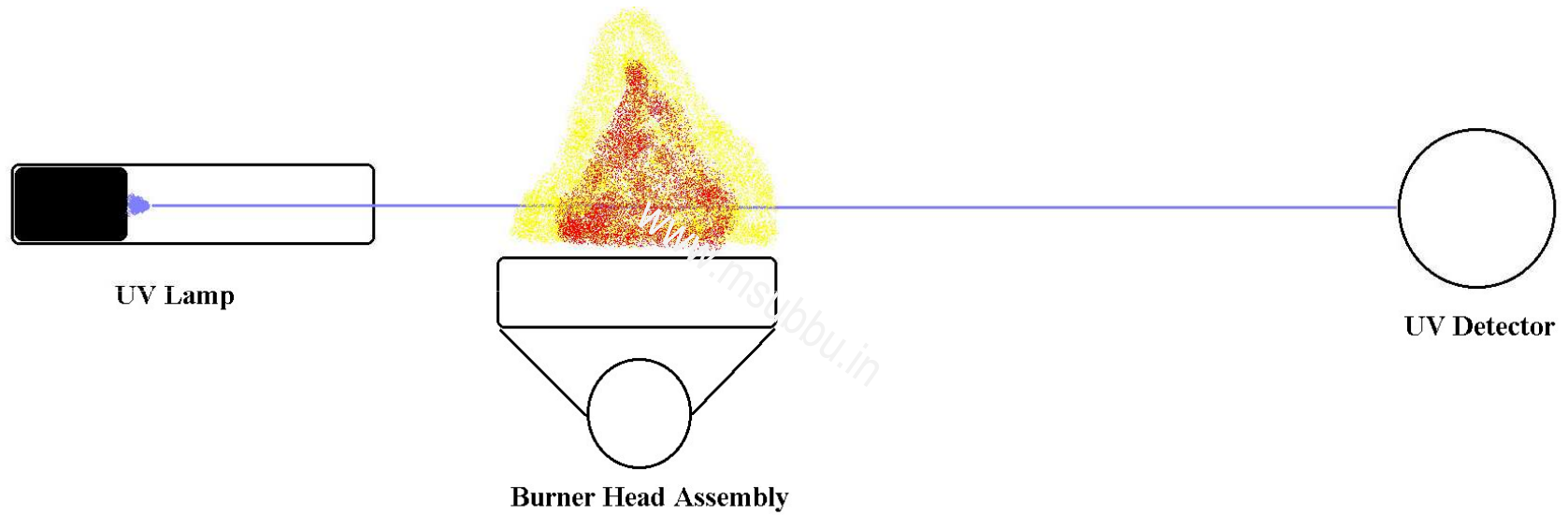

Components of AAS

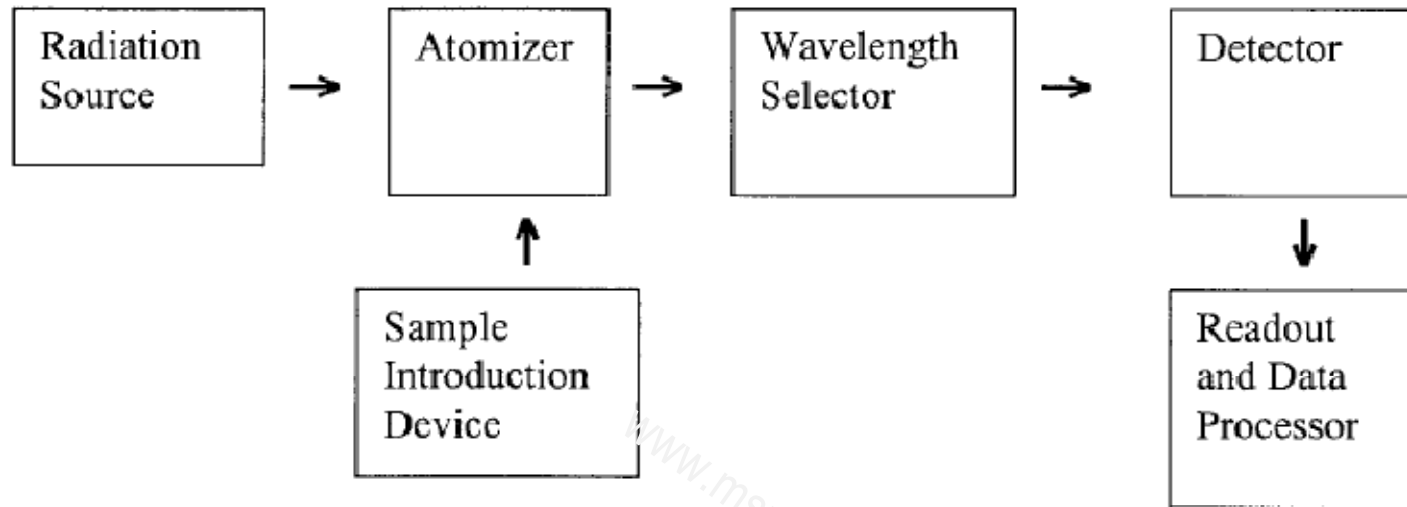

- Light from a suitable source is directed through the atomizer, which serves as the sample cell, into a wavelength selector and then to a detector.
- The detector measures how much light is absorbed by the sample.
- The sample, usually in solution form, is introduced into the atomizer by some type of introduction device.
- The atomizer converts the sample to gas phase ground state atoms that can absorb the incident radiation

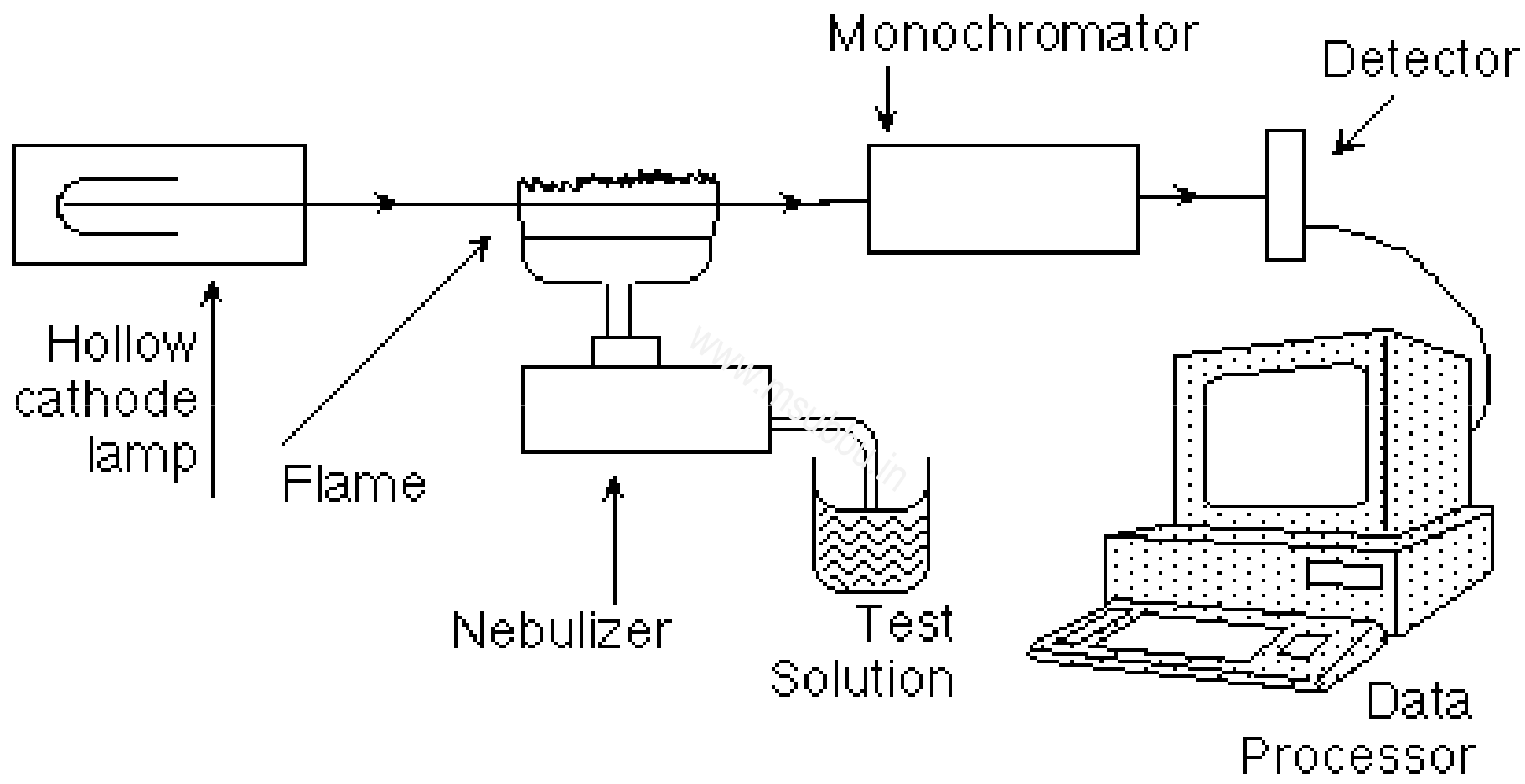

Radiation Sources

- Two radiation sources are commonly used in commercial AAS instruments, the hollow cathode lamp (HCL) and the electrodeless discharge lamp (EDL).

www.msubbu.in

Hollow Cathode Lamp

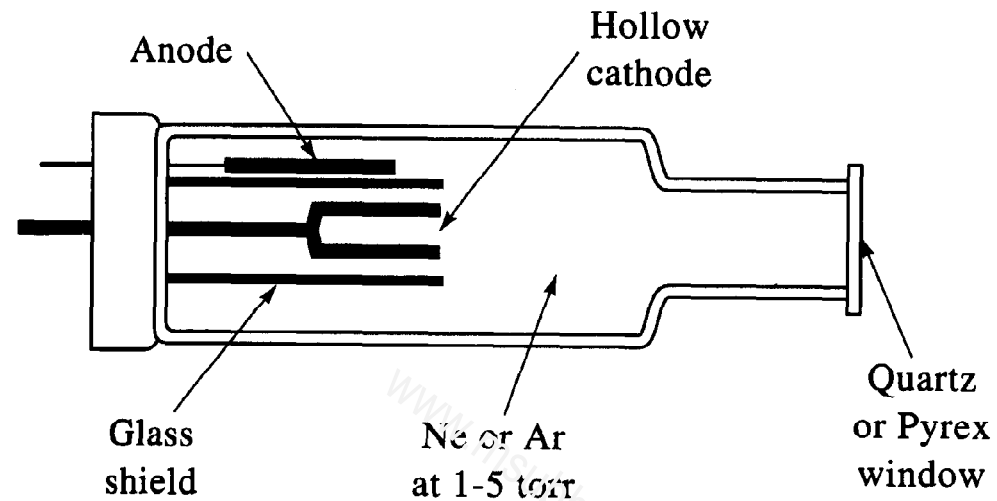

1. SPUTTERING

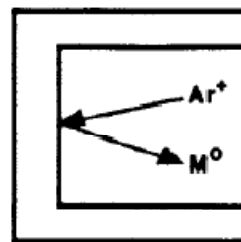

2. EXCITATION

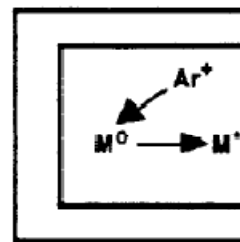

3. EMISSION

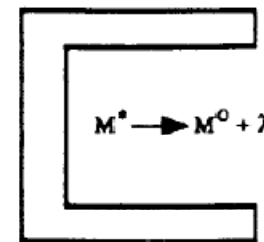

Each hollow cathode emits the spectrum of metal used in the cathode.

Electrodeless Discharge Lamp (EDL)

- It is difficult to make stable hollow cathodes from certain elements, particularly those that are volatile, such as arsenic, germanium, or selenium. The HCLs of these elements have short lifetimes and low intensities. An alternative light source has been developed in the EDL.
- A small amount of metal or a salt of the element whose spectrum is desired is sealed into a quartz bulb with a low pressure of Ar gas. The bulb is shown centered inside the coils. When power is applied to the coils, the RF field generated will “couple” with the metal or salt in the quartz bulb. The coupled energy will vaporize and excite the metal atoms in the bulb. The characteristic emission spectrum of the metal will be produced.

Electrodeless Discharge Lamp

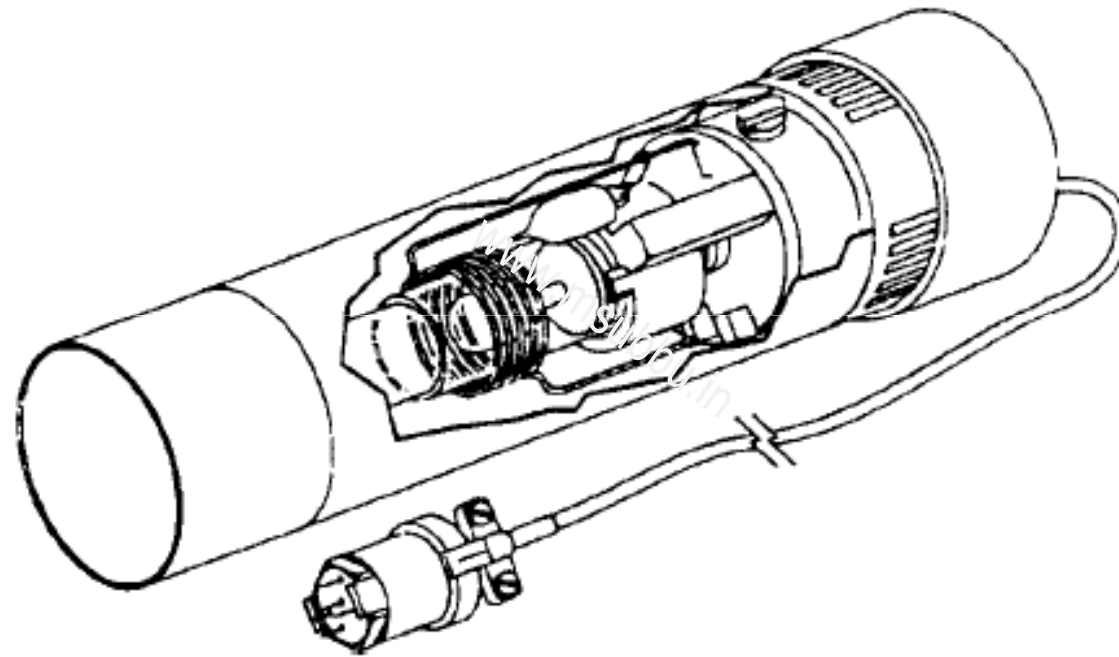

EDL lamps cost slightly more than the comparable HCL.

Atomizers

- The atomizer is the sample cell of the AAS system.
- Path length of cell is about 5 to 10 cm.
- The atomizer must produce the ground state free gas phase atoms necessary for the AAS process to occur.
- The analyte atoms are generally present in the sample as salts, molecular compounds, or complexes. The atomizer must convert these species to the reduced, free gas phase atomic state.
- The two most common atomizers are flame atomizers and electrothermal (furnace) atomizers.

Flame Atomization Process

- Most samples we want to examine by AAS are solid or liquid materials. Examples of solid samples are soil, rock, biological tissues, food, metal alloys, ceramics, glasses, and polymers.
- Examples of liquid samples are water, wastewater, urine, blood, beverages, oil, petroleum products, and organic solvents.
- For flame AAS (FAAS) determinations, the sample must be in the form of a solution. This requires that most samples be prepared by acid digestion, fusion, ashing, or other forms of sample preparation to give us an aqueous, acidic solution, or a solution in a combustible organic solvent.

The processes occurring in flame atomization

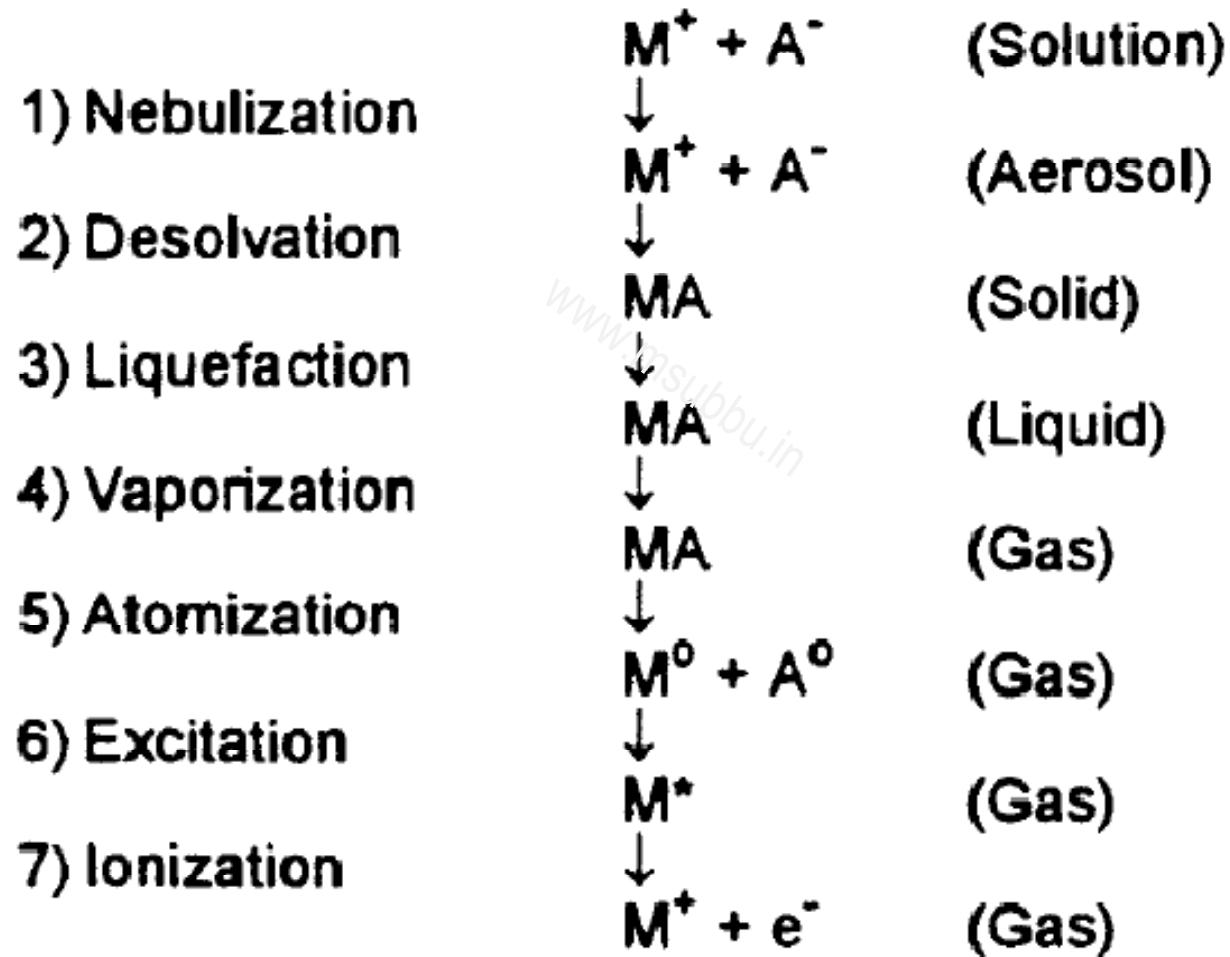

Monochromator

- A monochromator is required to separate the absorption line of interest from other spectral lines emitted from the HCL and from other elements in the atomizer that are also emitting their spectra.
- Most commercial AAS systems have the monochromator, optics, and detector designed for the measurement of one wavelength at a time; they are single-element instruments

Detectors

- The common detector for AAS is the Photomultiplier Tube (PMT)
- Other detectors such as Photodiode Array Detector (PDA) and Charge Coupled Device (CCD) are also used

www.msubbu.in

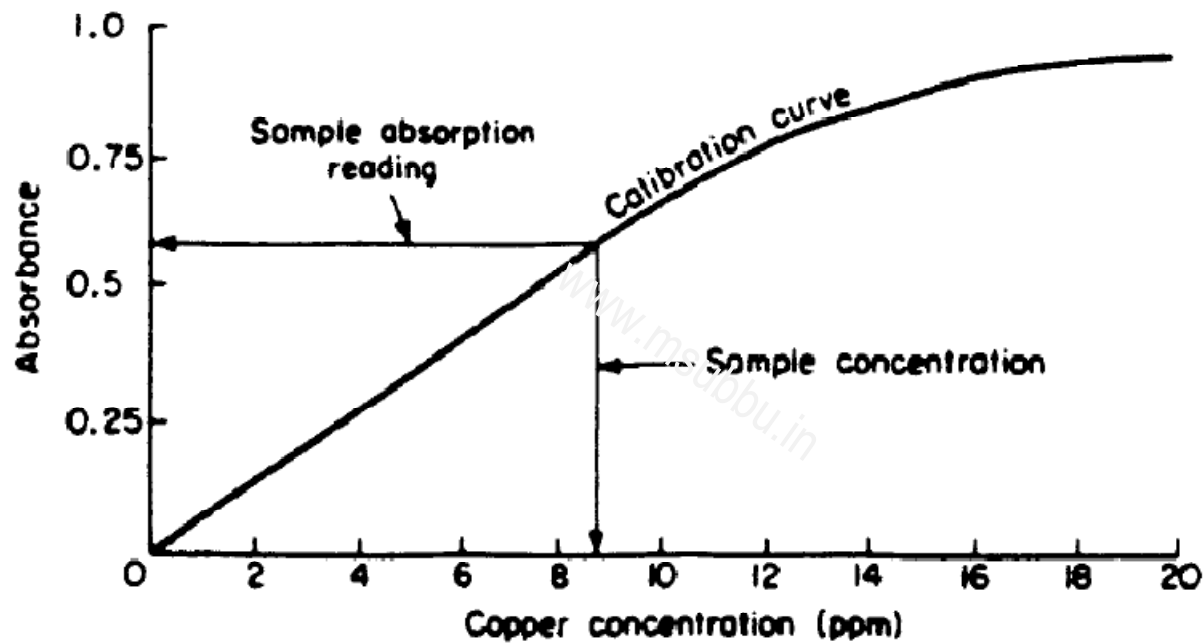

Figure 6.29 AAS calibration curve for the copper 324.8 nm line showing linear and nonlinear regions of the curve.

